

Waschplatz M3 / DWP 1200375-2AUSNCU-A

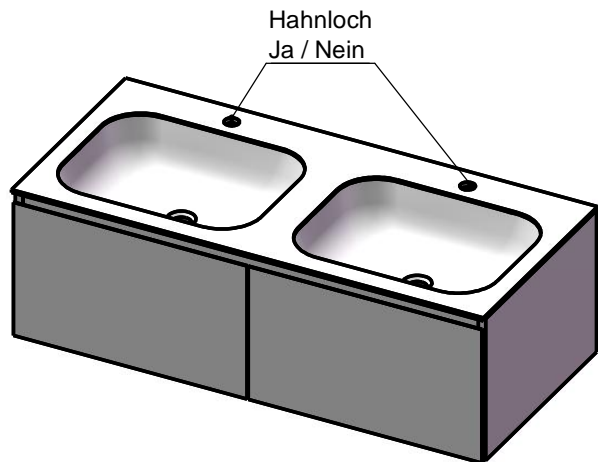
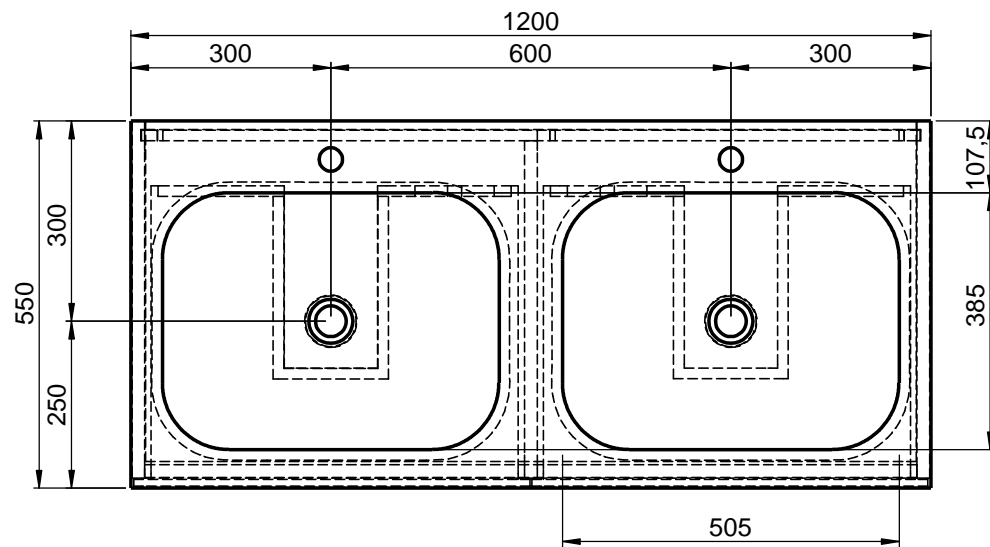
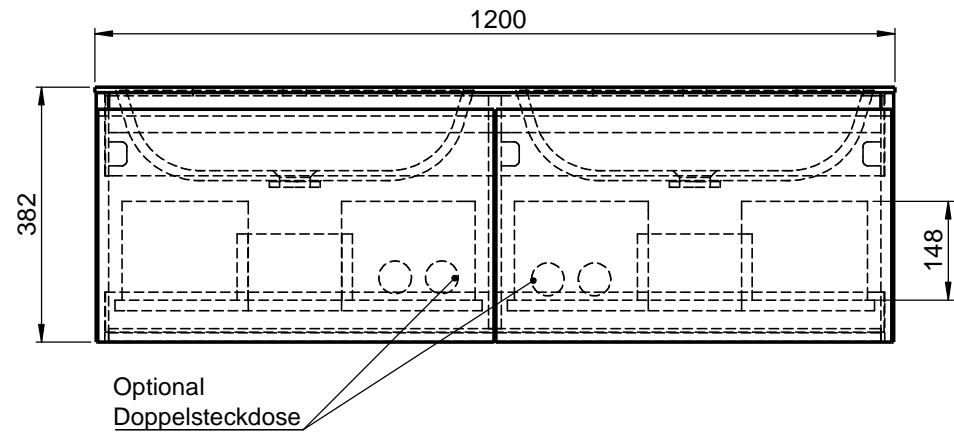
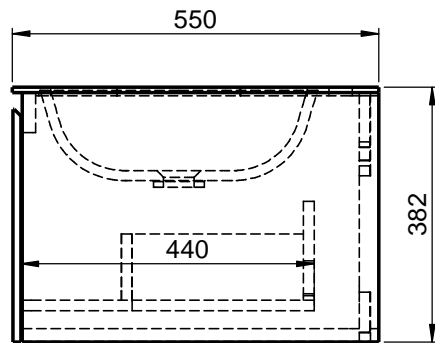

Wenn nicht anders definiert:
Bemessungen sind in Millimeter,
Toleranzen +/- 2mm

		Kunde:	Kunden-Nr.:
		Bestell-Nr.:	Raum:
NAME René Frank	DATUM	Kommission:	
FARBE:	Vorgang:	Beleg-Nr.:	
GEWICHT: 65.69 kg	letzte Änderung:	22.09.2020	Pos. 1
			BLATT 6 VON 9