

AUFSATZBECKEN | COUNTERTOP BASIN

ART. BEZEICHNUNG | ART. DESIGNATION

Juke Box

ARTIKEL-NR. | ARTICLE-NO.

JUK-2

MASSE | DIMENSIONS

395 x 275 x 165MM

GEWICHT | WEIGHT

10 KG

ÜBERLAUF | OVERFLOW

OHNE

domovari

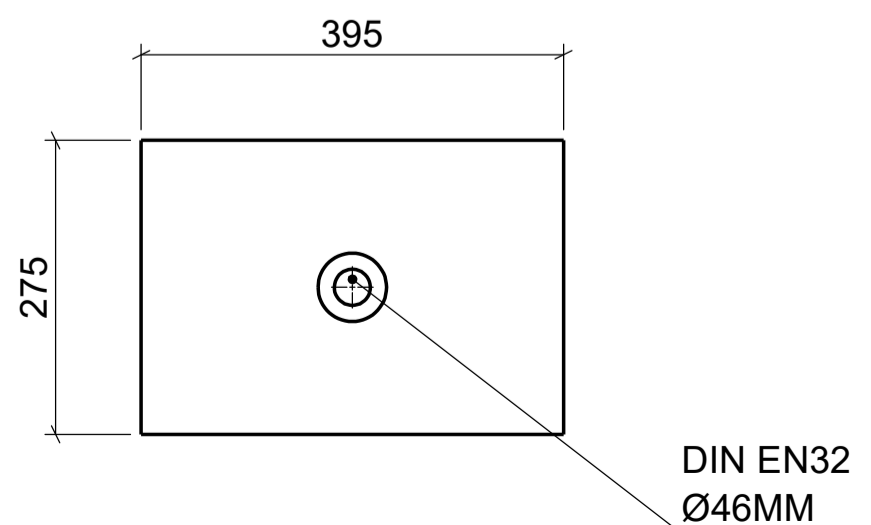
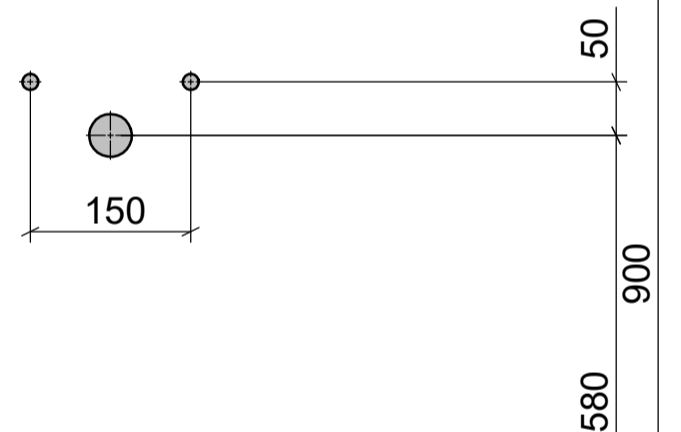
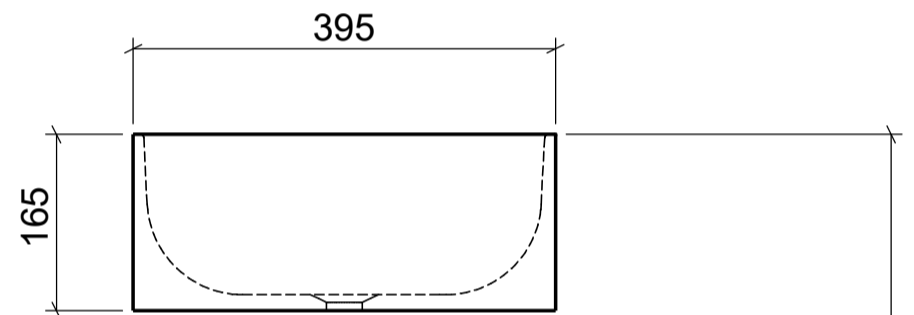
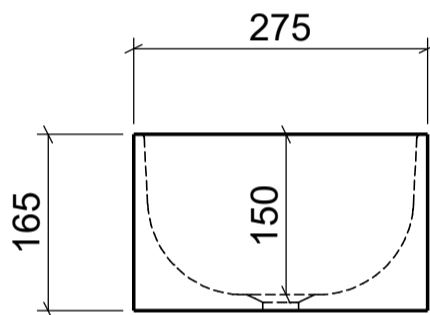
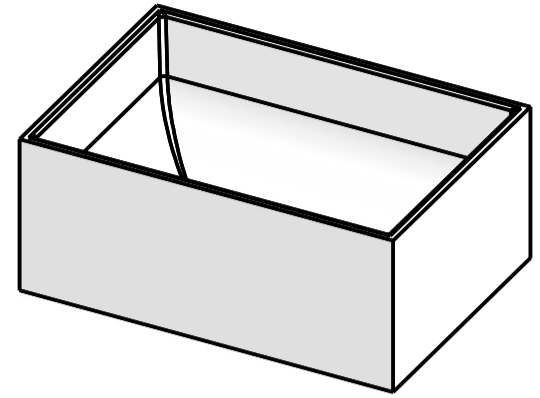

PFLEGEHINWEISE UND
MONTAGEANLEITUNGEN
FINDEN SIE AUF UNSERER
HOMEPAGE

CARE INSTRUCTIONS AND
ASSEMBLY INSTRUCTIONS
YOU WILL FIND IN OUR
HOMEPAGE

WWW.DOMOVARI.DE

+49 (0)2151/155090

MAIL@DOMOVARI.DE

