

# Waschplatz M2 / M2S-2-1655M

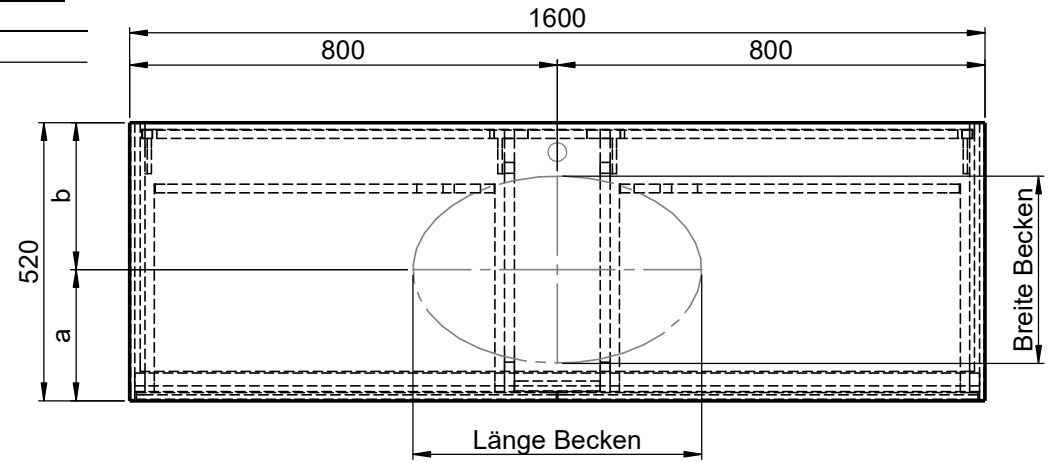

## Becken zur Auswahl:

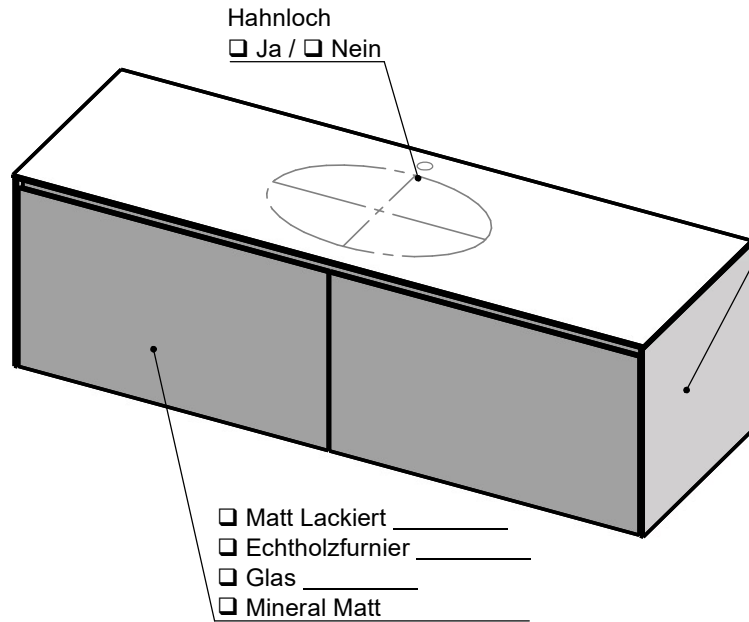
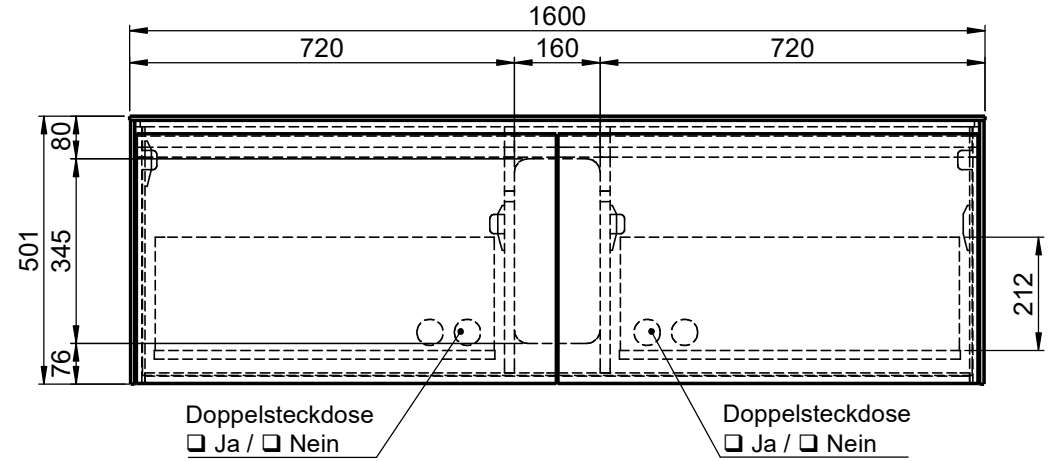
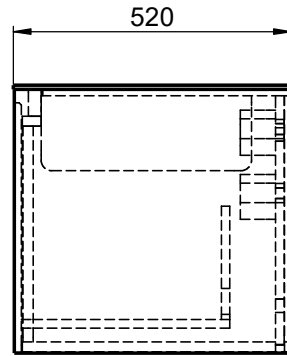
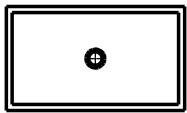

D80913  
 560x310x120mm  
 a=240mm / b=280mm

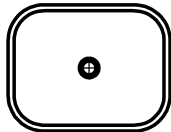

Curve II - Z795-4  
 500x300x120mm  
 a=235mm / b=285mm

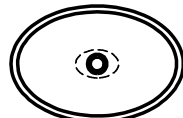

Epona - D883  
 540x350x120mm  
 a=245mm / b=275mm

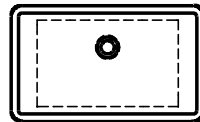

ERA-B1  
 600x340x100mm  
 a=245mm / b=275mm



FOV-DO  
 600x400x100mm  
 a=250mm / b=270mm

Wenn nicht anders definiert:  
 Bemessungen sind in Millimeter,  
 Toleranzen +/- 2mm

		Kunde:	Kunden-Nr.:
		Bestell-Nr.:	Raum:
NAME Marco Jentzsch	DATUM	Kommission:	
FARBE:	Vorgang:	Beleg-Nr.:	
GEWICHT: 93.8 kg		letzte Änderung:	16.04.2021
		Pos. 1	
		BLATT 32 VON 63	