

Waschplatz M2 / M2S-4-2055DX

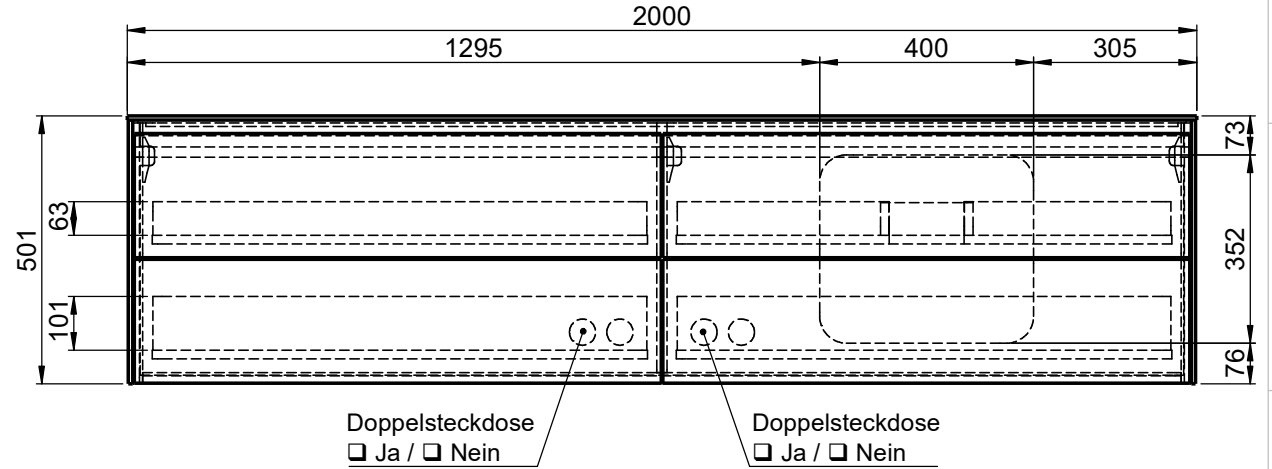

- Hahnloch Ja / Nein
- Matt Lackiert _____
- Echtholz furnier _____
- Mineral Matt _____

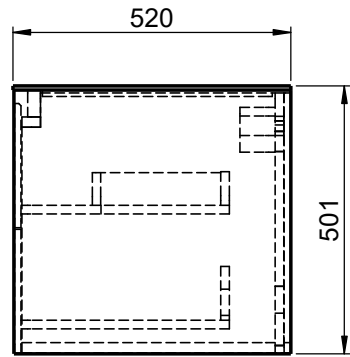
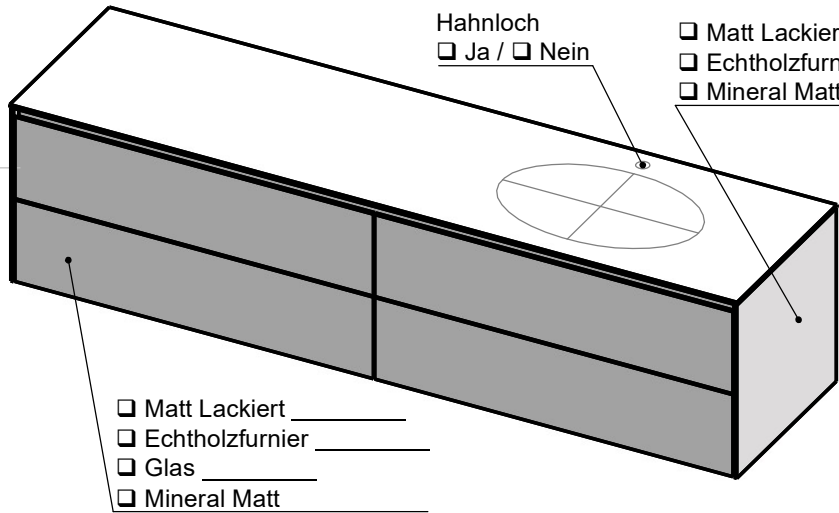

- Matt Lackiert _____
- Echtholz furnier _____
- Glas _____
- Mineral Matt _____

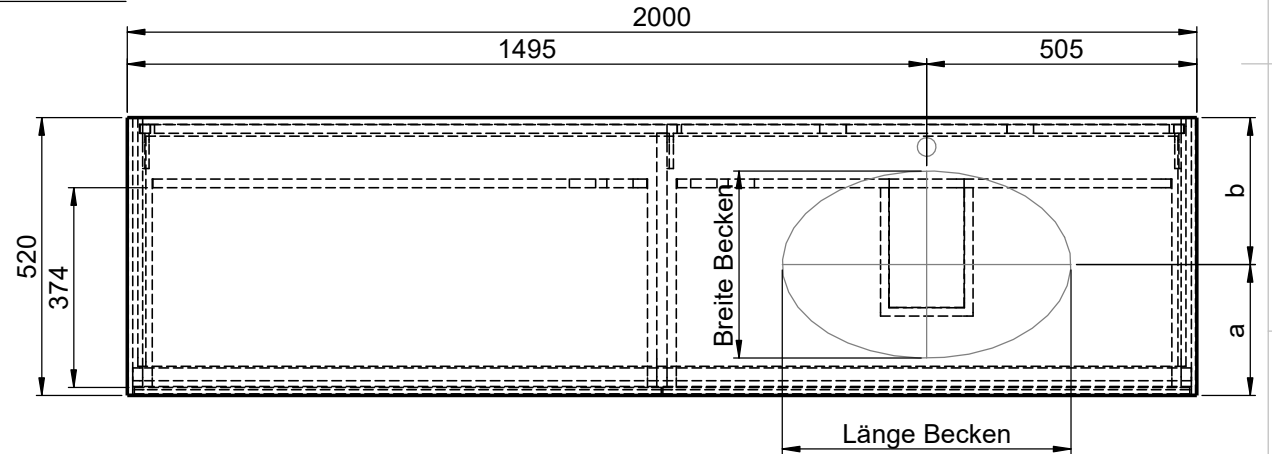

Becken zur Auswahl:

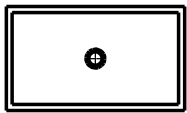

D80913
560x310x120mm
a=240mm / b=280mm

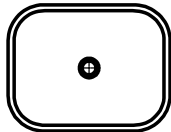

Curve II - Z795-4
500x300x120mm
a=235mm / b=285mm

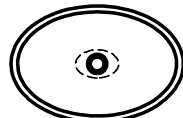

Epona - D883
540x350x120mm
a=245mm / b=275mm

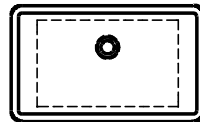

ERA-B1
600x340x100mm
a=245mm / b=275mm



FOV-DO
600x400x100mm
a=250mm / b=270mm

Wenn nicht anders definiert:
Bemassungen sind in Millimeter,
Toleranzen +/- 2mm

domovari

NAME: Marco Jentzsch
FARBE:

Kunde: _____
Bestell-Nr.: _____
Raum: _____
Kommission: _____

Vorgang: _____
Beleg-Nr.: _____



Pos. 1

GEWICHT: 116.53 kg

letzte Änderung: 25.06.2021

BLATT 48 VON 72