

# Waschplatz M2 / M2S-2-1653DX

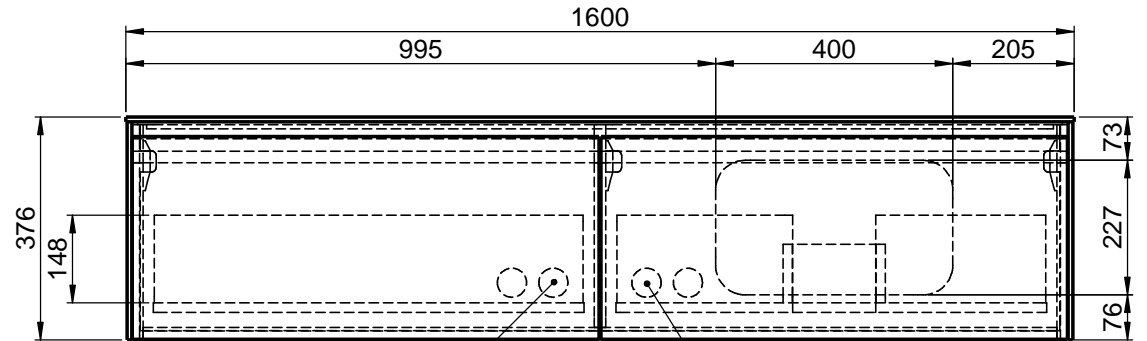

Doppelsteckdose  
 Ja /  Nein

Doppelsteckdose  
 Ja /  Nein

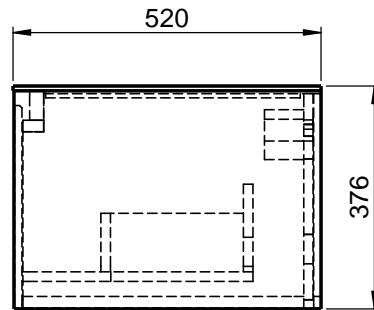
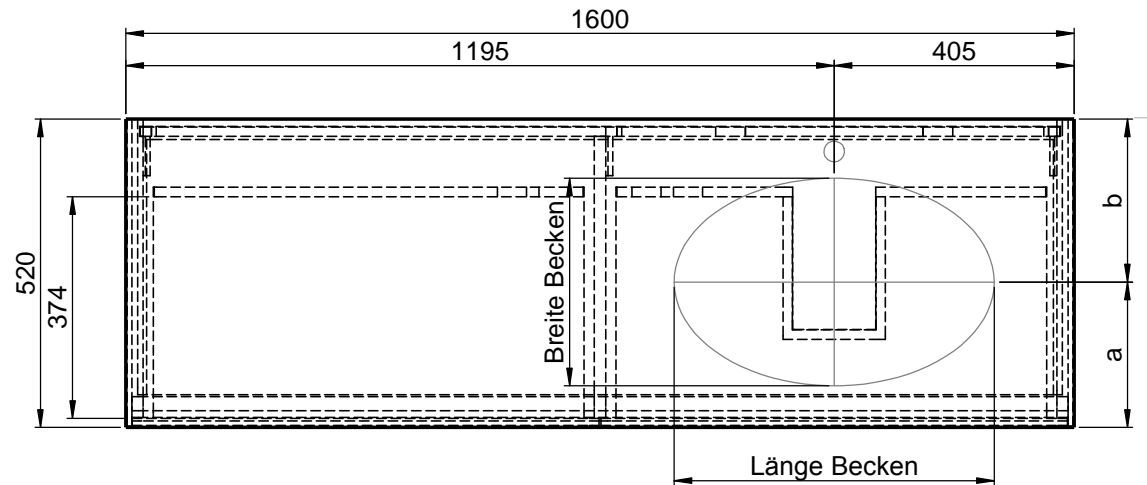
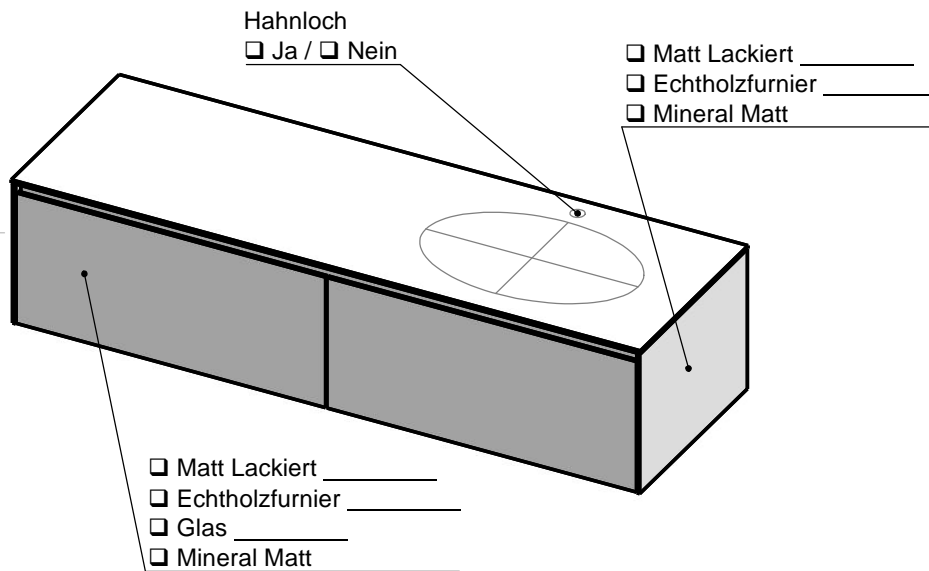

## Becken zur Auswahl:



D80913  
 560x310x120mm  
 a=240mm / b=280mm



Curve II - Z795-4  
 500x300x120mm  
 a=235mm / b=285mm

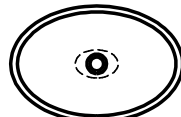

Epona - D883  
 540x350x120mm  
 a=245mm / b=275mm

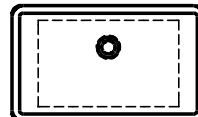

ERA-B1  
 600x340x100mm  
 a=245mm / b=275mm

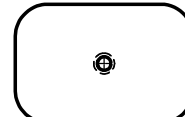

FOV-DO  
 600x400x100mm  
 a=250mm / b=270mm

Wenn nicht anders definiert:  
 Bemessungen sind in Millimeter,  
 Toleranzen +/- 2mm

**domovari**

NAME  
 René Frank  
 FARBE:

Kunde: \_\_\_\_\_ Kunden-Nr.: \_\_\_\_\_

Bestell-Nr.: \_\_\_\_\_ Raum: \_\_\_\_\_

Kommission: \_\_\_\_\_

Vorgang: \_\_\_\_\_

Beleg-Nr.: \_\_\_\_\_



Pos. 1

GEWICHT: 78.41 kg

letzte Änderung: \_\_\_\_\_

24.04.2019

BLATT 10 VON 33