

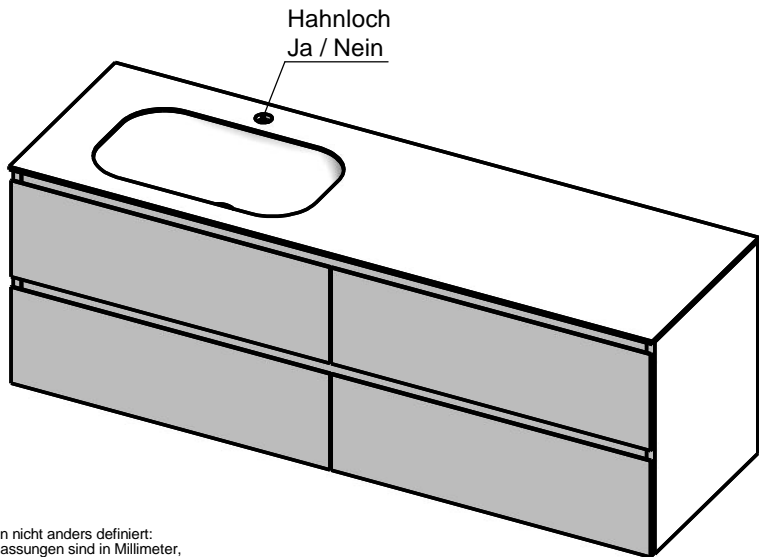

Waschplatz M3 / WP 1500500-4AUSNCUL-47

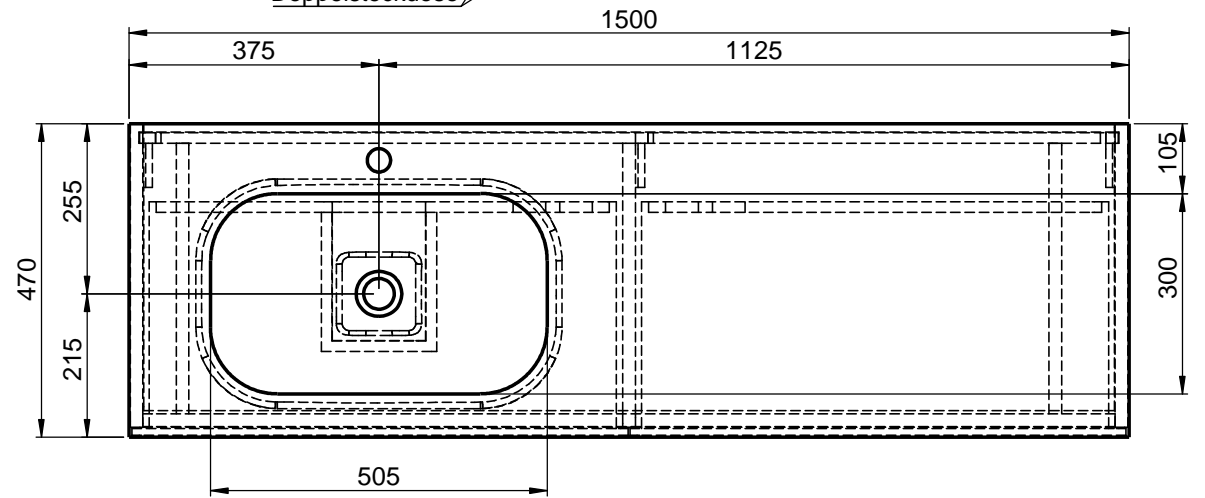
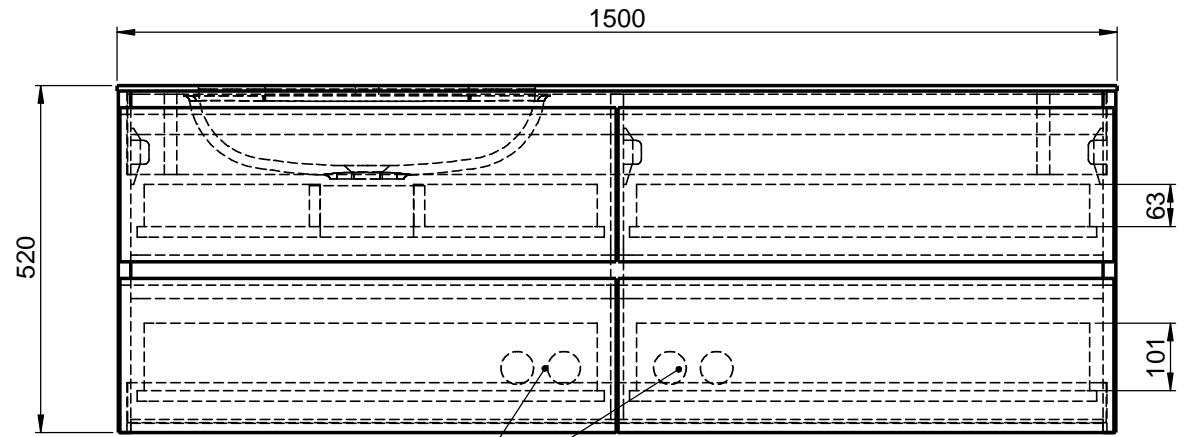
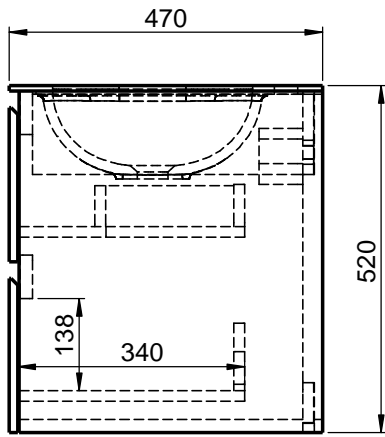

Wenn nicht anders definiert:
Bemessungen sind in Millimeter,
Toleranzen +/- 2mm

domovari

NAME
René Frank
FARBE:

Kunde:	Kunden-Nr.:	
Bestell-Nr.:	Raum:	
Kommission:		
Vorgang:		Beleg-Nr.:
GEWICHT: 92.12 kg	letzte Änderung: 24.08.2020	Pos. 1
		BLATT 6 VON 9