

Waschplatz M3 / WP 1800500-4AUSNCUL-47

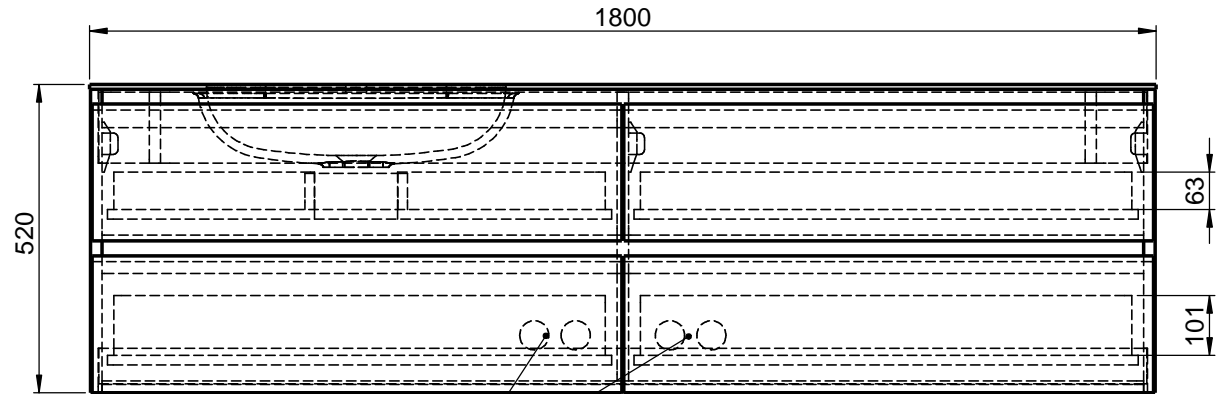

Optional
Doppelsteckdose

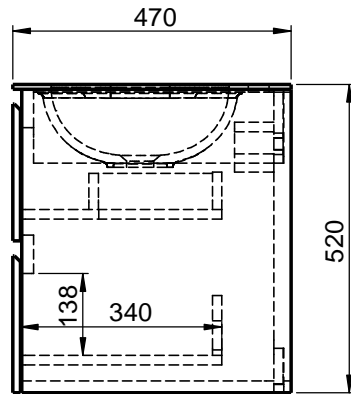
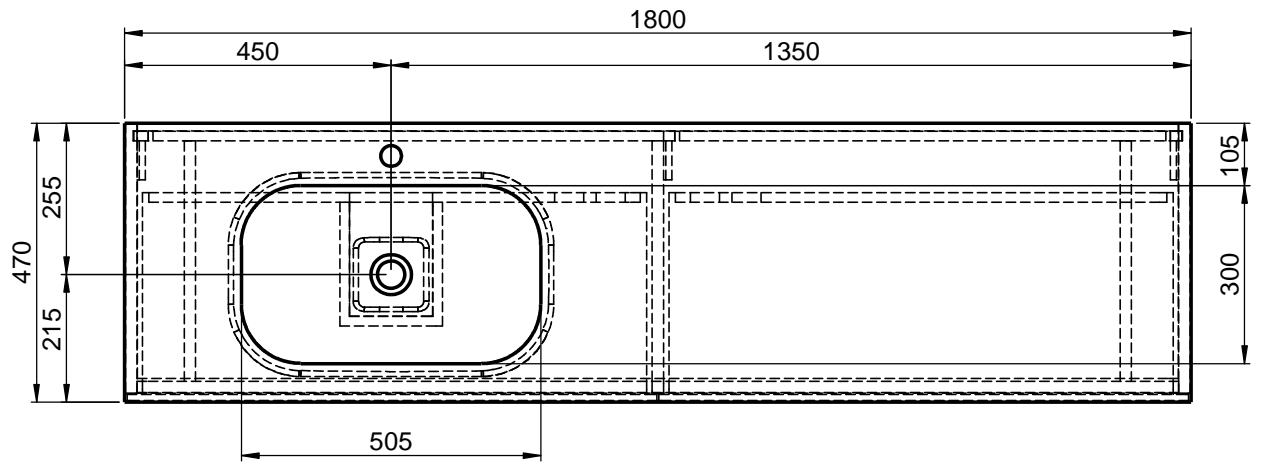

Hahnloch
Ja / Nein

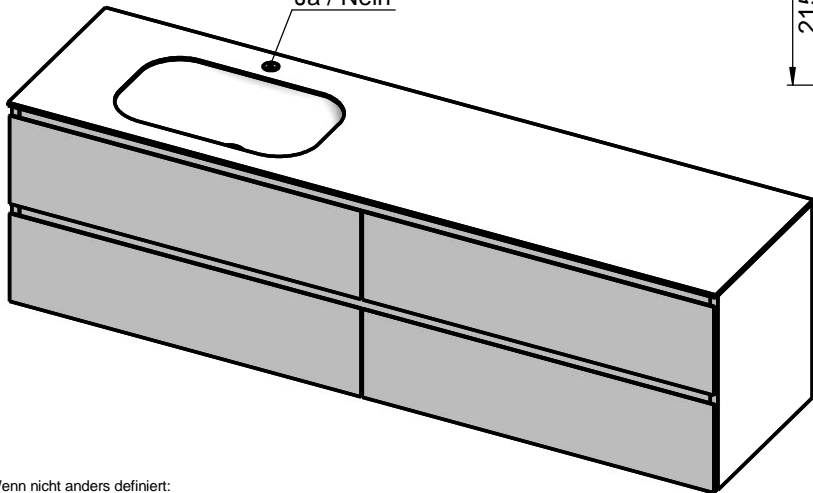

Wenn nicht anders definiert:
Bemassungen sind in Millimeter,
Toleranzen +/- 2mm

domovari		Kunde:	Kunden-Nr.:
		Bestell-Nr.:	Raum:
NAME René Frank	DATUM	Kommission:	
FARBE:	Vorgang:	Beleg-Nr.:	
GEWICHT: 105.85 kg	letzte Änderung:	24.08.2020	Pos. 1 BLATT 6 VON 9