

# Waschplatz M3 / WP 800375-1AUSER-A

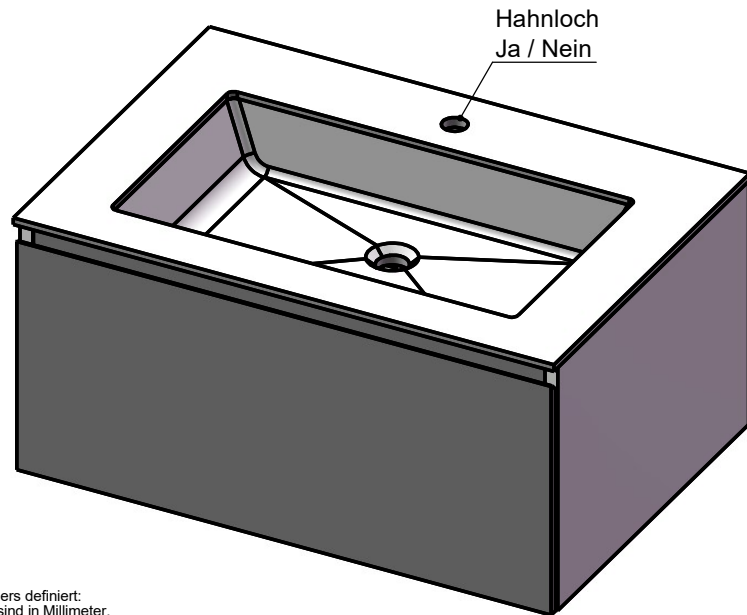
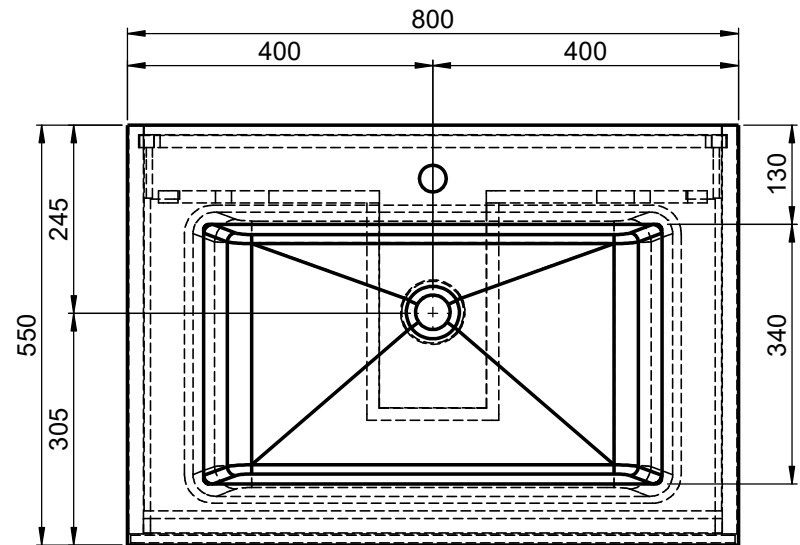
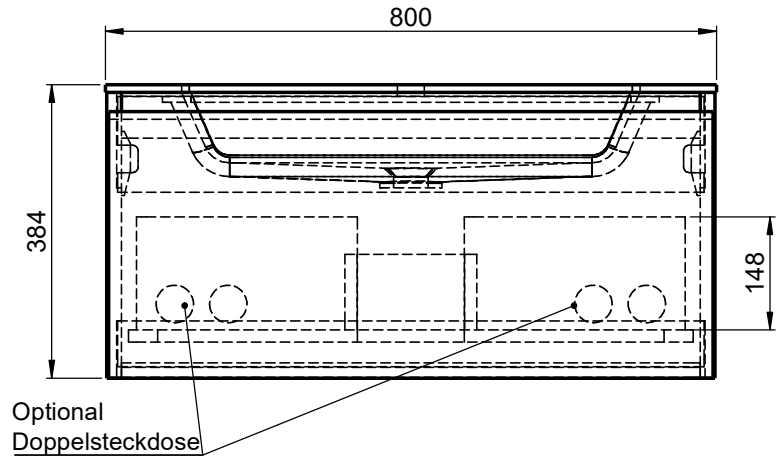
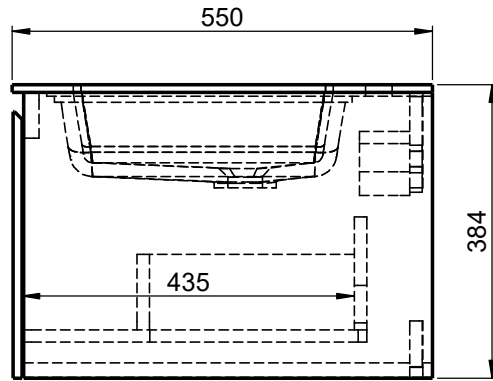

Wenn nicht anders definiert:  
Bemassungen sind in Millimeter,  
Toleranzen +/- 2mm

		Kunde:	Kunden-Nr.:
		Bestell-Nr.:	Raum:
NAME Marco Jentzsch	DATUM	Kommission:	
FARBE:	Vorgang:	Beleg-Nr.:	
GEWICHT: 47.47 kg		letzte Änderung:	26.03.2021
Pos. 1			BLATT 6 VON 9